

Universaalne riulisüsteem LONGSPAN

Suuremahuliste kaupade käsiladustamiseks mõeldud riul.

- Külgraami kõrgus kuni 6000 mm.
- Tugev külgraami konstruktsioon võimaldab korrusladude rajamist.
- Riiulitasapindade reguleerimissamm: 50 mm.
- Riiulipostid – sinised (RAL 5003).
- Riiulitalad – oranžid (RAL 2004) või galvaniseeritud (Zn).
- Riiulitala mõõdud sobivad ka EUR-aluste ladustamiseks.
- Külgraamide sügavused: **400**; 500; **600**; 700; **800**; 900; **1000**; 1100; **1200** mm.
- Külgraamide kõrgused meetrites: 1,8; **2,0**; 2,25; **2,5**; 2,75; **3,0**; 3,5; **4,0**; 4,5; **5,0**; 5,5; **6,0** m.
- Väiksematele koormustele on pakkuda kergemat külgraami – **522**, max kandevõime 2000 kg. Suurematele koormustele – 525 B, max kandevõime 4000 kg.

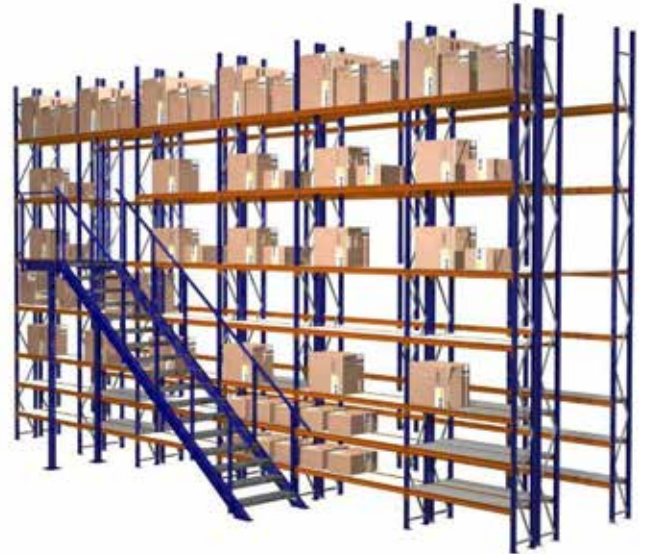

Z-talad

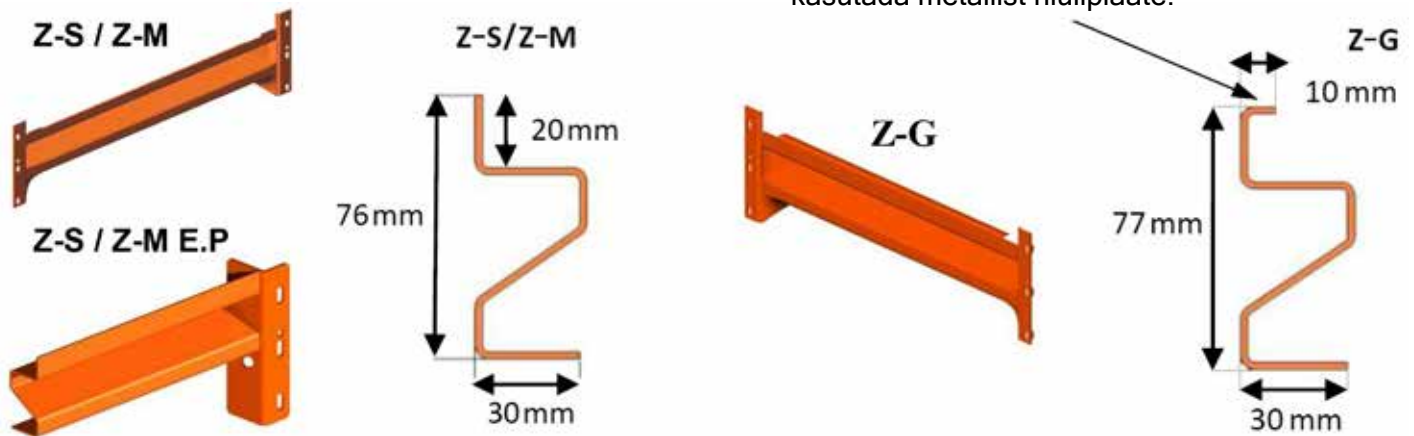

NB! Z-G tala puhul ei ole võimalik kasutada metallist riuliplaate!

NB! Z-S, Z-M ja Z-G on stantsitud talad. Z-S ja Z-M erinevad üksteisest materjali paksuse poolest. Z-S E.P, Z-M E.P ja Z-G E.P on keevitatud talad, kasulikku talapinda vähem (-8 mm).

Talapaari maksimaalne kandevõime (kg), koormuse ühtlase jaotuse korral.

Tala tüüp	Tala pikkus (mm)								
	950	1150	1350	1500	1800	1850	2250	2400	2700
Z-S	-	882	750	674	530	510	368	332	-
Z-S / E.P	1102				-				
Z-M	1414	1148	966	864	715	692	520	474	402
Z-M / E.P					-				
Z-G	1606	1286	1092	982	-	790	556	498	406
Z-G / E.P									-

Karptalad



Step 73 E.P

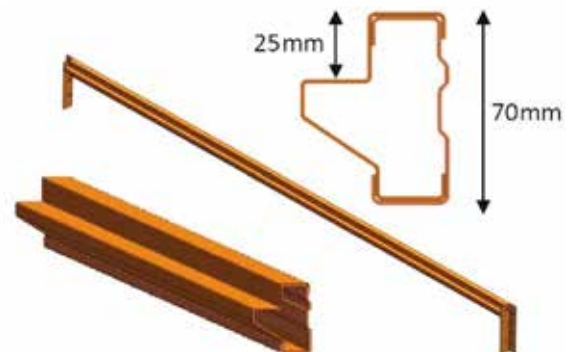

Talapaari maksimaalne kandevõime (kg), koormuse ühtlase jaotuse korral.

Tala tüüp	Tala pikkus (mm)						
	950	1150	1350	1500	1850	2250	2700
52 / E.P	-	1300	1050	-	750	575	-
73 / E.P	2300	-	1700	-	1400	1100	900
STEP 73 / E.P	-	-	1800	1500	1480	1200	1000

Torutalad

ROUND Ø 30 x 2 mm



Talapaari maksimaalne kandevõime (kg), koormuse ühtlase jaotuse korral.

Tala tüüp	Tala pikkus (mm)					
	950	1350	1500	1800	1850	2700
ROUND 30x2mm	510	315	280	220	210	80

Riulitasapinna moodustamise võimalused

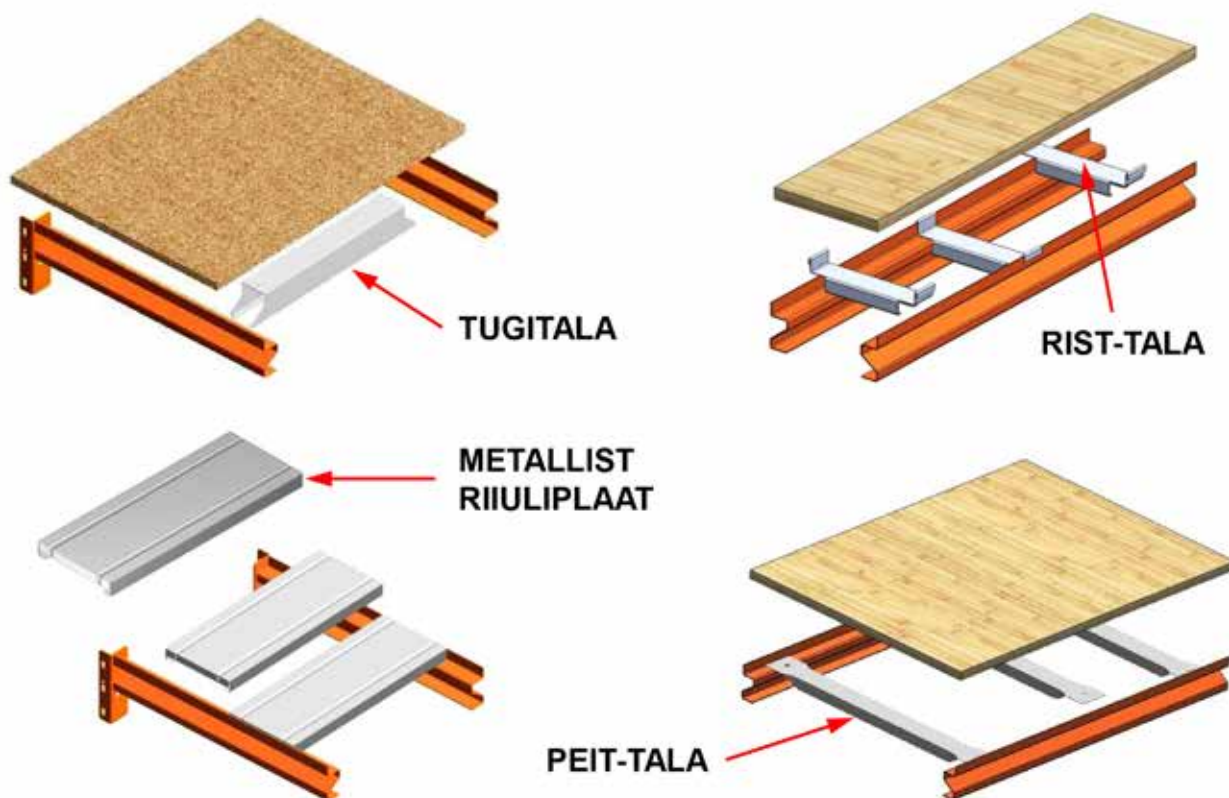

Riulitalade pikkuse korral üle 2 meetri soovitame talade väändumise vältimiseks (tekib suurte koormuste ladustamisel) kasutada vähemalt ühte rist-tala iga talapaari kohta, kui riulitasapind ise pole talade külge kinnitatud. PLP-plaadi kasutamisel soovitame kasutada plaadi läbipainde vältimiseks peit-taladid ca 60 cm intervalliga.

Tugi- ja rist-talade pikkused: **400**; 500; **600**; 700; **800**; 900; **1000**; 1100 ja **1200** mm.

Peit-talade pikkused: **800**; 1000; **1100** ja 1200 mm.

Metallist riuliplaatide 150 x 25 ja 300 x 25 mm (laius x kõrgus) pikkused: **400**; 500; **600**; 700; **800**; 900; **1000**; 1100 ja **1200** mm.

525A külgraamide komplekteerimine

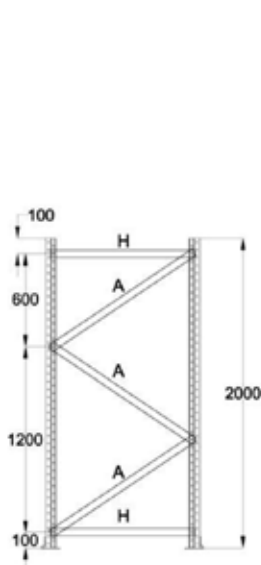

H = 2000 mm

horisontaal H	2 tk
diagonaal A	3 tk
horisontaali hülss	2 tk
polt M6 x 40 mm	6 tk
mutter M6	6 tk

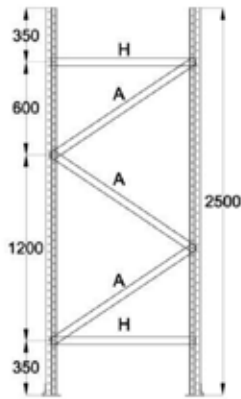

H = 2500 mm

horisontaal H	2 tk
diagonaal A	3 tk
horisontaali hülss	2 tk
polt M6 x 40 mm	6 tk
mutter M6	6 tk

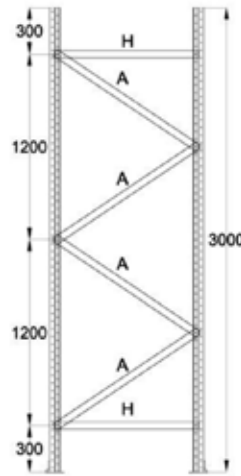

H = 3000 mm

horisontaal H	2 tk
diagonaal A	4 tk
horisontaali hülss	2 tk
polt M6 x 40 mm	7 tk
mutter M6	7 tk

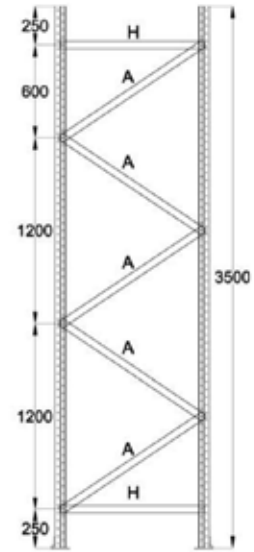

H = 3500 mm

horisontaal H	2 tk
diagonaal A	5 tk
horisontaali hülss	2 tk
polt M6 x 40 mm	8 tk
mutter M6	8 tk

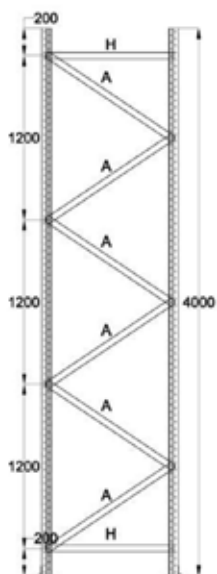

H = 4000 mm

horisontaal H	2 tk
diagonaal A	6 tk
horisontaali hülss	2 tk
polt M6 x 40 mm	9 tk
mutter M6	9 tk

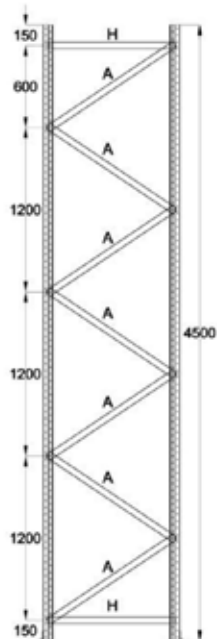

H = 4500 mm

horisontaal H	2 tk
diagonaal A	7 tk
horisontaali hülss	2 tk
polt M6 x 40 mm	10 tk
mutter M6	10 tk

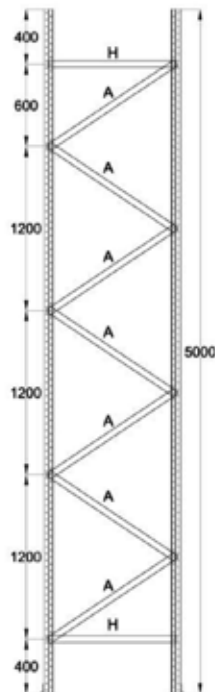

H = 5000 mm

horisontaal H	2 tk
diagonaal A	7 tk
horisontaali hülss	2 tk
polt M6 x 40 mm	10 tk
mutter M6	10 tk

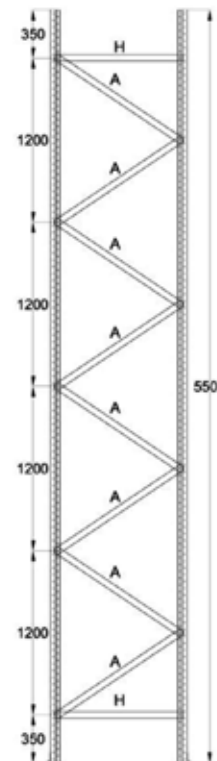

H = 5500 mm

horisontaal H	2 tk
diagonaal A	8 tk
horisontaali hülss	2 tk
polt M6 x 40 mm	11 tk
mutter M6	11 tk

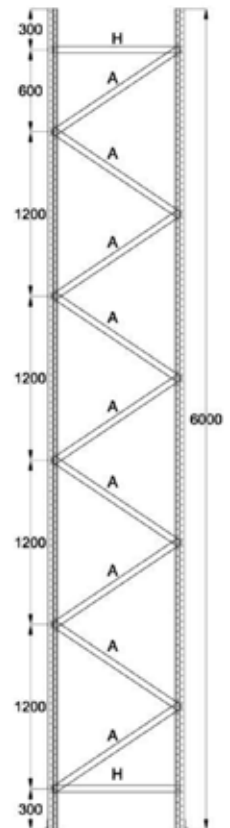

H = 6000 mm

horisontaal H	2 tk
diagonaal A	9 tk
horisontaali hülss	2 tk
polt M6 x 40 mm	12 tk
mutter M6	12 tk

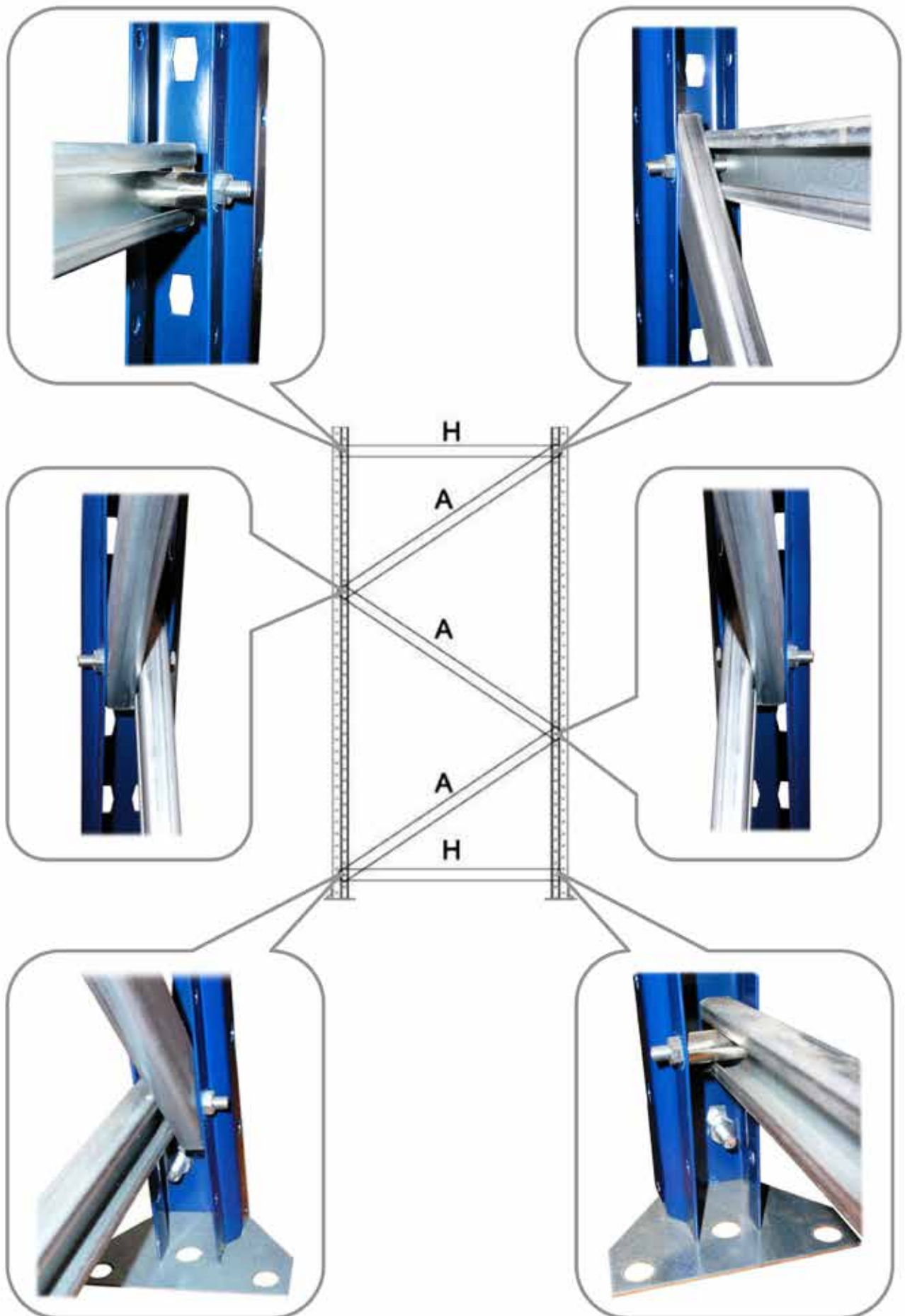

Veel LongSpan riuli kasutusvõimalusi

**Laomaailm AS**

Linamäe 2 Tännassilma küla

76406 Saku vald

Harjumaa, Eesti

info@storit.ee

www.storit.ee